

**Dual common source
Fast Trench + Field Stop IGBT®
Power Module**

**$V_{CES} = 1200V$
 $I_C = 300A @ T_c = 80^\circ C$**

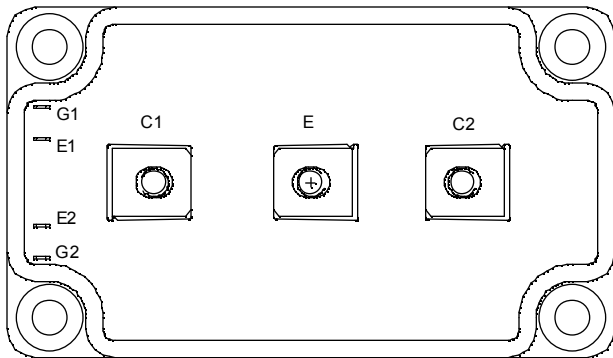
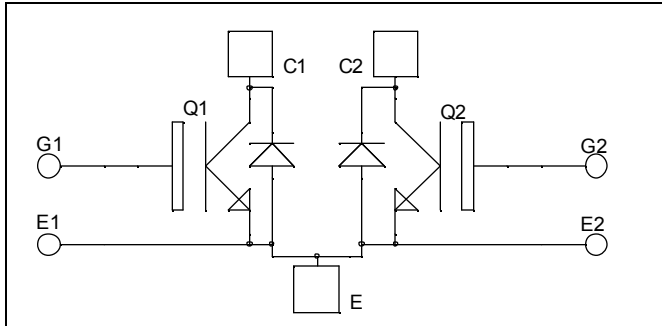

Application

- AC Switches
- Switched Mode Power Supplies
- Uninterruptible Power Supplies

Features

- Fast Trench + Field Stop IGBT® Technology
 - Low voltage drop
 - Low tail current
 - Switching frequency up to 20 kHz
 - Soft recovery parallel diodes
 - Low diode VF
 - Low leakage current
 - Avalanche energy rated
 - RBSOA and SCSOA rated
- Kelvin emitter for easy drive
- Very low stray inductance
 - Symmetrical design
 - M5 power connectors
- High level of integration

Benefits

- Stable temperature behavior
- Very rugged
- Direct mounting to heatsink (isolated package)
- Low junction to case thermal resistance
- Easy paralleling due to positive TC of VCEsat
- Low profile
- RoHS Compliant

Absolute maximum ratings

| Symbol | Parameter | Max ratings | Unit |
|-----------|---------------------------------------|---------------------|--------------|
| V_{CES} | Collector - Emitter Breakdown Voltage | 1200 | V |
| I_C | Continuous Collector Current | $T_c = 25^\circ C$ | 420 |
| | | $T_c = 80^\circ C$ | 300 |
| I_{CM} | Pulsed Collector Current | $T_c = 25^\circ C$ | 600 |
| V_{GE} | Gate - Emitter Voltage | ± 20 | V |
| P_D | Maximum Power Dissipation | $T_c = 25^\circ C$ | 1380 |
| RBSOA | Reverse Bias Safe Operating Area | $T_j = 125^\circ C$ | 600A @ 1100V |

CAUTION: These Devices are sensitive to Electrostatic Discharge. Proper Handling Procedures Should Be Followed. See application note APT0502 on www.microsemi.com

All ratings @ $T_j = 25^\circ\text{C}$ unless otherwise specified

Electrical Characteristics

| Symbol | Characteristic | Test Conditions | Min | Typ | Max | Unit | |
|---------------|--------------------------------------|------------------------------------------------|-------------------------------------------------------|------------|------------|---------------|---|
| I_{CES} | Zero Gate Voltage Collector Current | $V_{GE} = 0\text{V}$, $V_{CE} = 1200\text{V}$ | | | 500 | μA | |
| $V_{CE(sat)}$ | Collector Emitter Saturation Voltage | $V_{GE} = 15\text{V}$ $I_C = 300\text{A}$ | $T_j = 25^\circ\text{C}$ $T_j = 125^\circ\text{C}$ | 1.4 2.0 | 1.7 2.1 | V | |
| $V_{GE(th)}$ | Gate Threshold Voltage | $V_{GE} = V_{CE}$, $I_C = 4\text{mA}$ | | 5.0 | 5.8 | 6.5 | V |
| I_{GES} | Gate – Emitter Leakage Current | $V_{GE} = 20\text{V}$, $V_{CE} = 0\text{V}$ | | | 600 | nA | |

Dynamic Characteristics

| Symbol | Characteristic | Test Conditions | Min | Typ | Max | Unit |
|--------------|------------------------------|-------------------------------------------------------------------------------------------------------------------------------------------------|---------------------------|-----|-----|------|
| C_{ies} | Input Capacitance | $V_{GE} = 0\text{V}$ | | 21 | | nF |
| C_{oes} | Output Capacitance | $V_{CE} = 25\text{V}$ | | 1.2 | | |
| C_{res} | Reverse Transfer Capacitance | $f = 1\text{MHz}$ | | 0.9 | | |
| $T_{d(on)}$ | Turn-on Delay Time | Inductive Switching (25°C) $V_{GE} = \pm 15\text{V}$ $V_{Bus} = 600\text{V}$ $I_C = 300\text{A}$ $R_G = 1.8\Omega$ | | 260 | | ns |
| T_r | Rise Time | | | 30 | | |
| $T_{d(off)}$ | Turn-off Delay Time | | | 420 | | |
| T_f | Fall Time | | | 70 | | |
| $T_{d(on)}$ | Turn-on Delay Time | Inductive Switching (125°C) $V_{GE} = \pm 15\text{V}$ $V_{Bus} = 600\text{V}$ $I_C = 300\text{A}$ $R_G = 1.8\Omega$ | | 290 | | ns |
| T_r | Rise Time | | | 50 | | |
| $T_{d(off)}$ | Turn-off Delay Time | | | 520 | | |
| T_f | Fall Time | | | 90 | | |
| E_{on} | Turn on Energy | $V_{GE} = \pm 15\text{V}$ $V_{Bus} = 600\text{V}$ | $T_j = 125^\circ\text{C}$ | 30 | | mJ |
| E_{off} | Turn off Energy | $I_C = 300\text{A}$ $R_G = 1.8\Omega$ | $T_j = 125^\circ\text{C}$ | 30 | | |

Reverse diode ratings and characteristics

| Symbol | Characteristic | Test Conditions | Min | Typ | Max | Unit |
|-----------|-----------------------------------------|----------------------------------------------------------------------------------|------|-------------------------------------------------------|-------------------------------------------------------|---------------|
| V_{RRM} | Maximum Peak Repetitive Reverse Voltage | | 1200 | | | V |
| I_{RM} | Maximum Reverse Leakage Current | $V_R = 1200\text{V}$ | | | $T_j = 25^\circ\text{C}$ $T_j = 125^\circ\text{C}$ | μA |
| I_F | DC Forward Current | | | 300 | | A |
| V_F | Diode Forward Voltage | $I_F = 300\text{A}$ $V_{GE} = 0\text{V}$ | | $T_j = 25^\circ\text{C}$ $T_j = 125^\circ\text{C}$ | 1.6 2.1 | V |
| t_{rr} | Reverse Recovery Time | $I_F = 300\text{A}$ $V_R = 600\text{V}$ $di/dt = 3000\text{A}/\mu\text{s}$ | | $T_j = 25^\circ\text{C}$ $T_j = 125^\circ\text{C}$ | 170 280 | ns |
| Q_{rr} | Reverse Recovery Charge | | | $T_j = 25^\circ\text{C}$ $T_j = 125^\circ\text{C}$ | 27 54 | μC |
| E_r | Reverse Recovery Energy | | | $T_j = 25^\circ\text{C}$ $T_j = 125^\circ\text{C}$ | 15 27 | mJ |

Thermal and package characteristics

Symbol Characteristic

| | | | <i>Min</i> | <i>Typ</i> | <i>Max</i> | <i>Unit</i> |
|-------------------|-----------------------------------------------------------------------------------------|---------------|------------|------------|------------|-------------|
| R _{thJC} | Junction to Case Thermal Resistance | IGBT | | | 0.09 | °C/W |
| | | Diode | | | 0.17 | |
| V _{ISOL} | RMS Isolation Voltage, any terminal to case t = 1 min, I _{isol} < 1mA, 50/60Hz | | 2500 | | | V |
| T _J | Operating junction temperature range | | -40 | | 150 | °C |
| T _{STG} | Storage Temperature Range | | -40 | | 125 | |
| T _C | Operating Case Temperature | | -40 | | 100 | |
| Torque | Mounting torque | To heatsink | M6 | 3 | 5 | N.m |
| | | For terminals | M5 | 2 | 3.5 | |
| Wt | Package Weight | | | | 280 | g |

SP6 Package outline (dimensions in mm)



See application note APT0601 - Mounting Instructions for SP6 Power Modules on www.microsemi.com

Typical Performance Curve

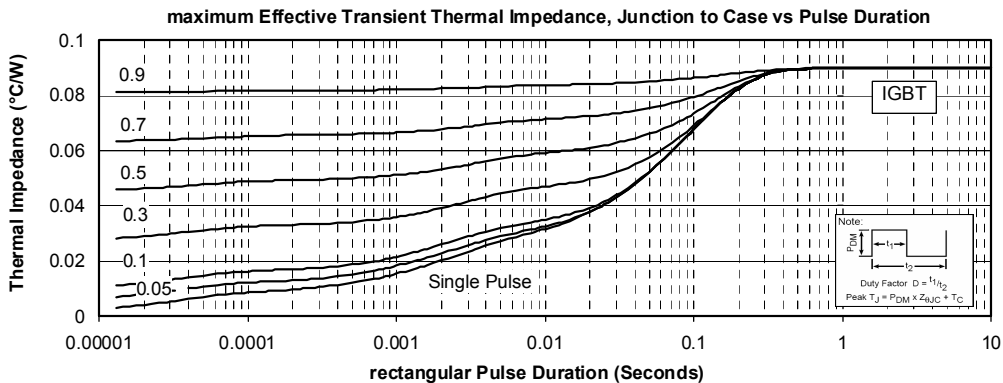
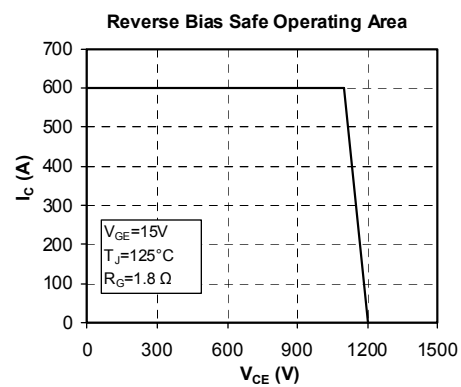
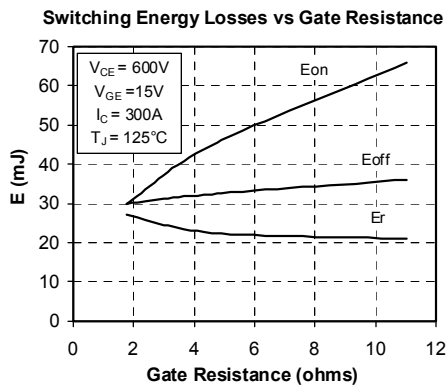
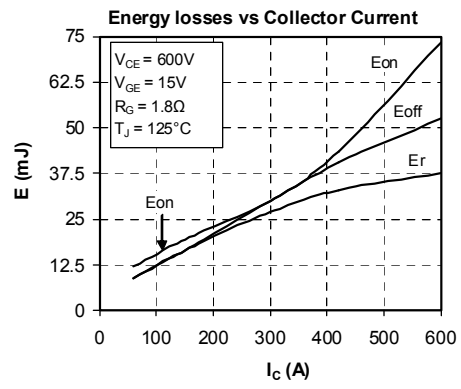
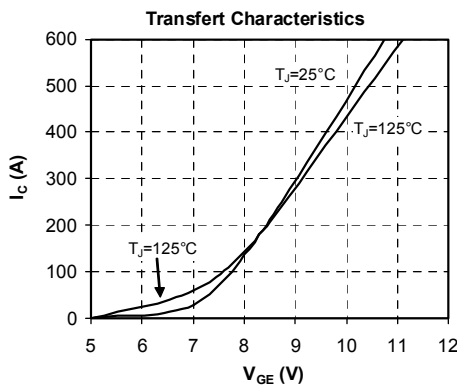
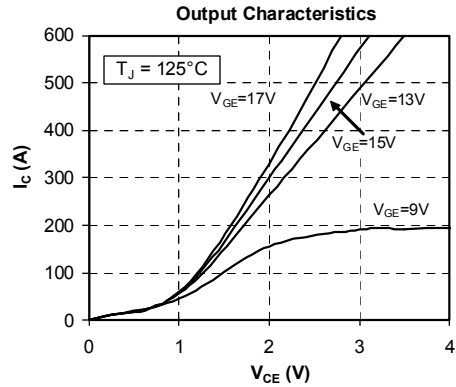
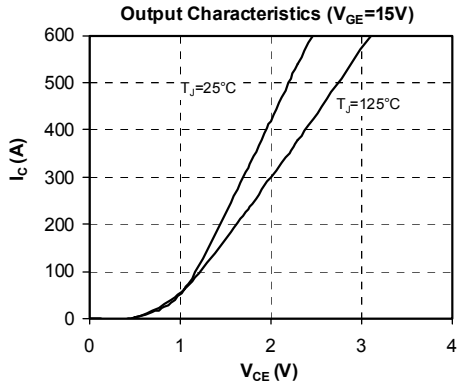

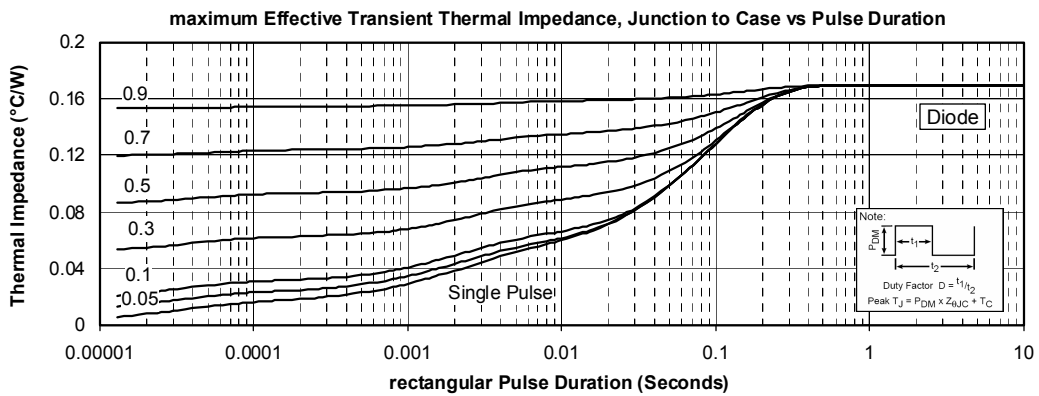
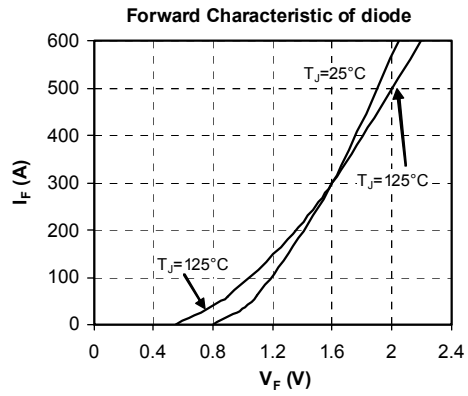
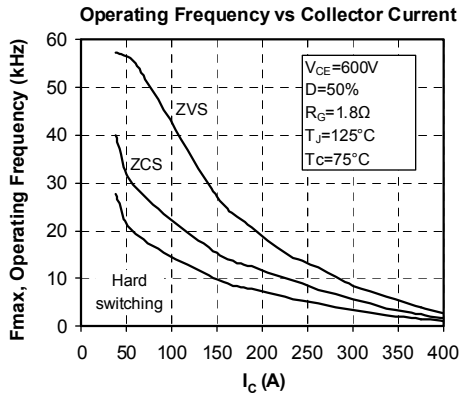

Microsemi reserves the right to change, without notice, the specifications and information contained herein

Microsemi's products are covered by one or more of U.S. patents 4,895,810 5,045,903 5,089,434 5,182,234 5,019,522 5,262,336 6,503,786 5,256,583 4,748,103 5,283,202 5,231,474 5,434,095 5,528,058 and foreign patents. U.S. and Foreign patents pending. All Rights Reserved.